

space for you

# UP cabinet

Istruzioni per il montaggio  
Assembly instruction  
Montageanleitungen  
Instructions pour le montage  
Istruccìon para el montaje  
Instrucões de montagem  
Instruțiuni de montaj  
Инструкции за монтаж  
Инструкции по монтажу  
Instruksione montimi  
Unstructies voor de montage  
Οδηγίες συναρμολόγησης  
Montaj talimatları

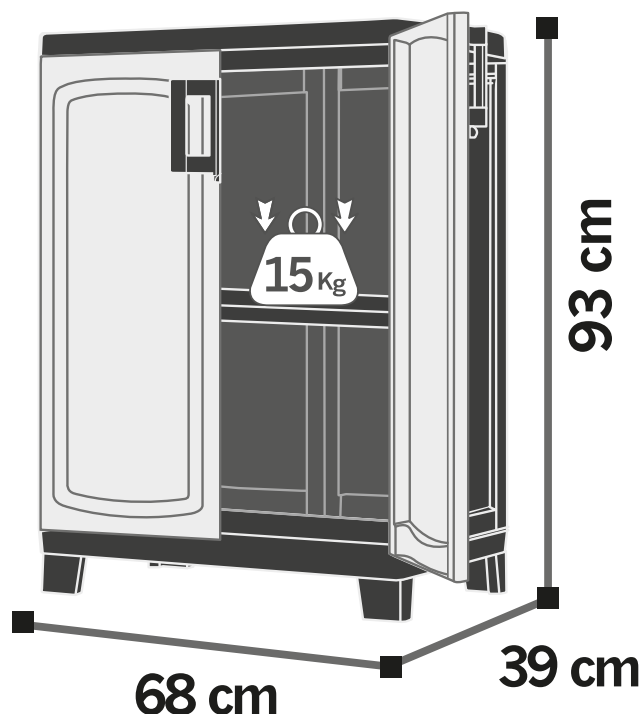

Art. 009852

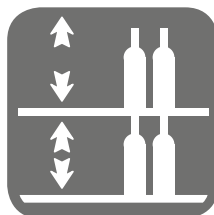

290350\_Rev00\_07/11

\* non incluso/not included/nicht inbegriffen/non incluses/no incluido/nao incluidos/niet inbegrepen/nije uključen/do zestawu/nincsenek mellékelve/bez nardędzi/nu sunt incluse/δεν περιλαμβάνονται/غير مدرج  
не е включено/Není součástí/følger ikke med/ei kuulu toimitukseen/別売り/ikke inkludert/Niedolączona do opakowania/Não incluido/Nije sadržan/Nie je súčasťou/Ingår inte/не включено до постачання/nincs mellékelve

Made in Italy

www.kis.it

a.b.m. Italia SpA - Via Ing. G. Taliercio 1 - 31024 Roncadelle di Ormelle (TV) - Italia  
Tel. +39 0422 745900 - Fax +39 0422 745999 - info@abmitalia.com

# Parts

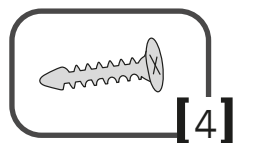
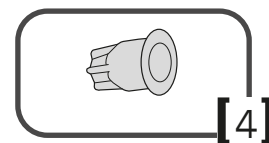
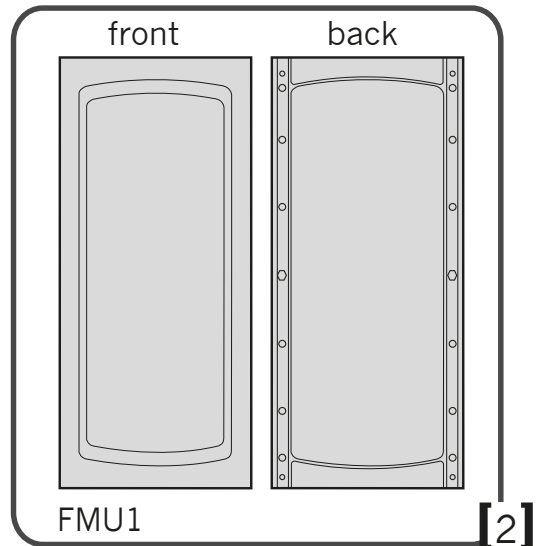
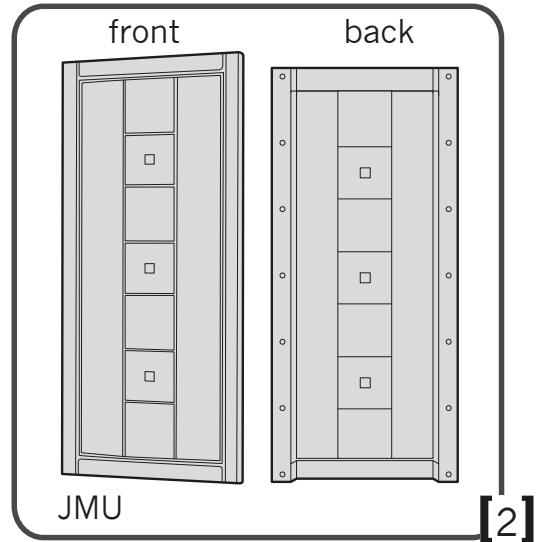
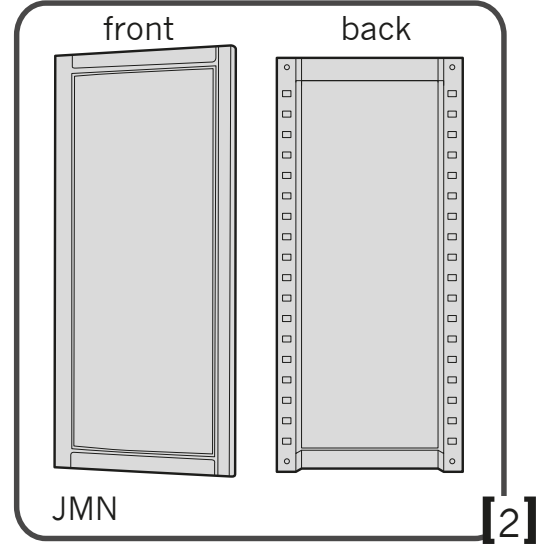
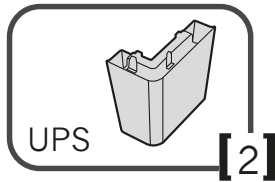
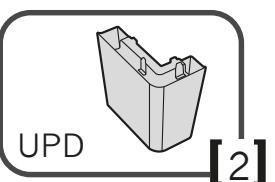
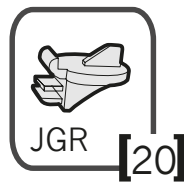
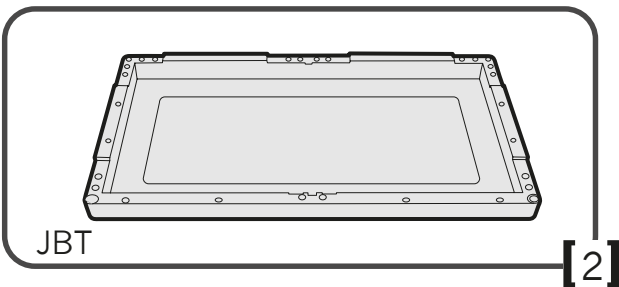
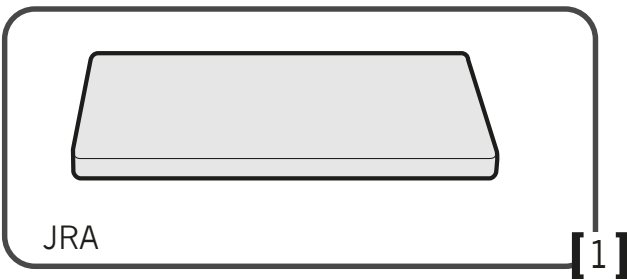
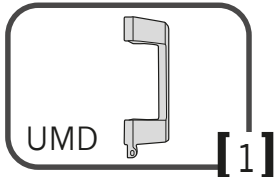
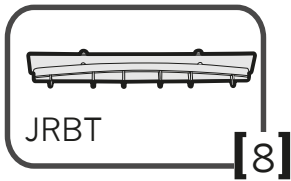
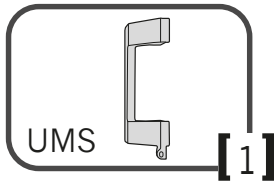
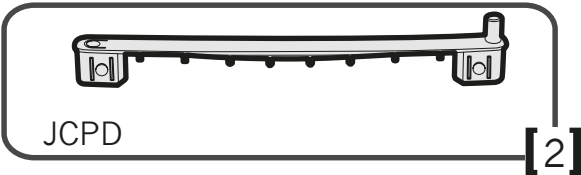
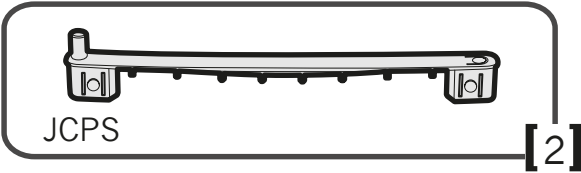
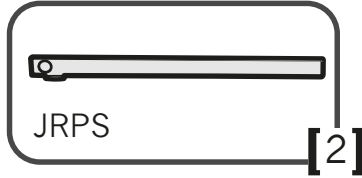
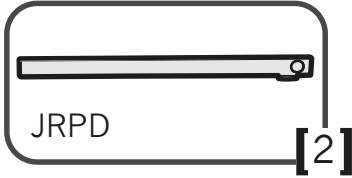
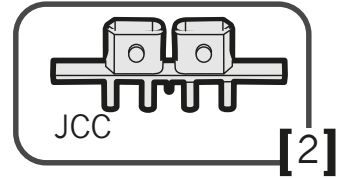
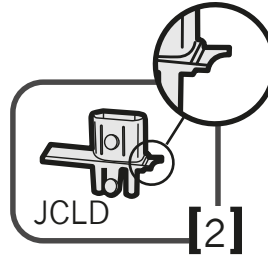
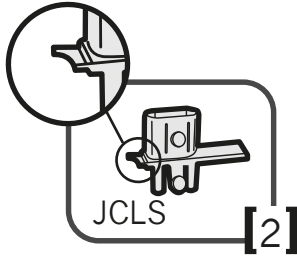
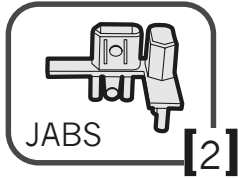
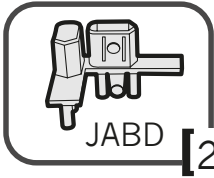

1



JBT



UPD x 2



UPS x 2

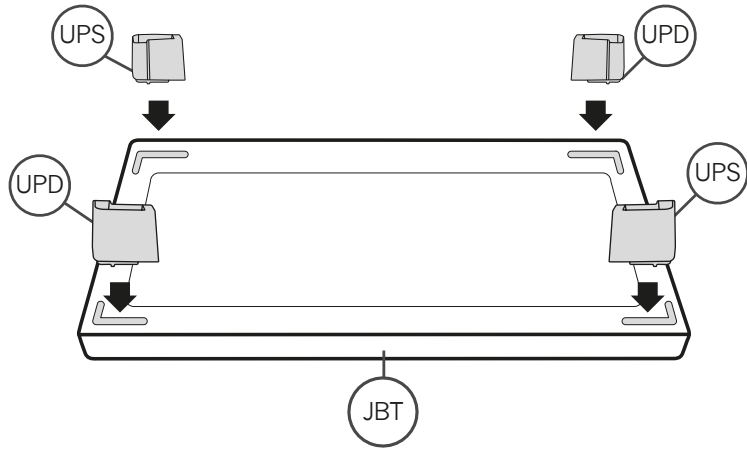

2



JRBT x 4



JRPS x 1



JRPD x 1

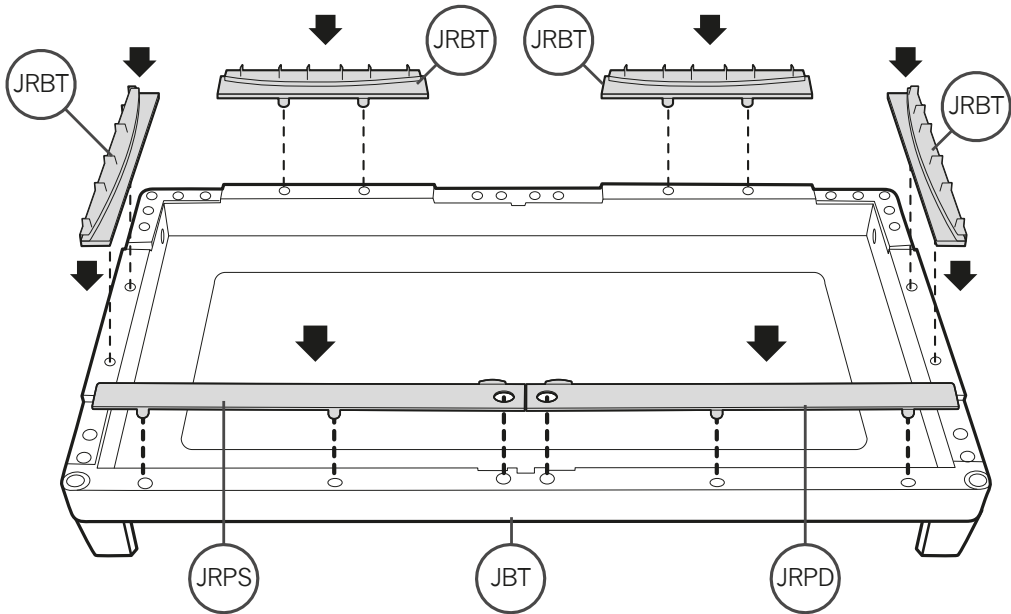

3

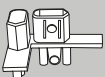

JABD x 1

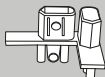

JABS x 1

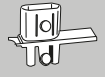

JCLS x 1

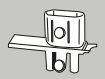

JCLD x 1



JCC x 1

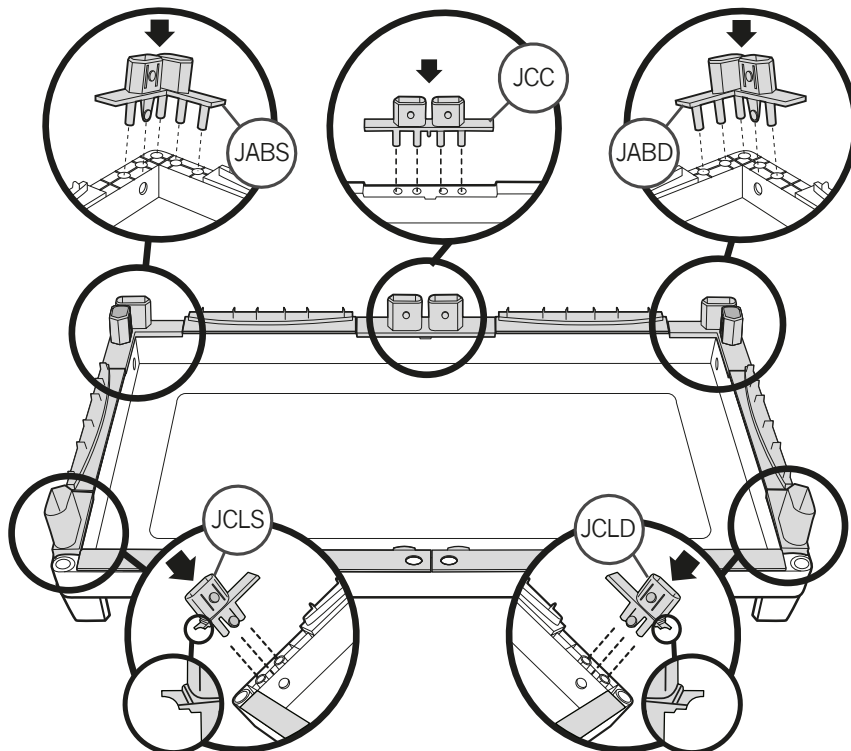

4

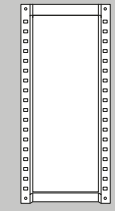

JMN x 2

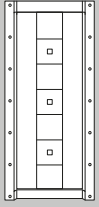

JMU x 2

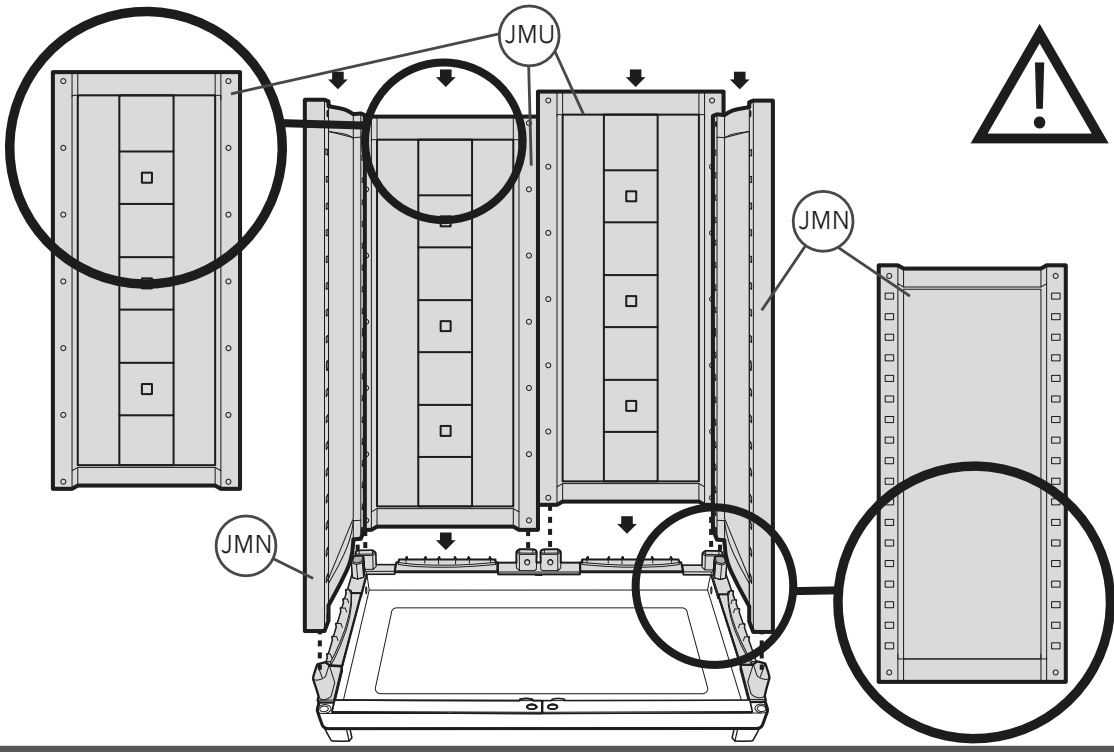

5



JCPS x 2



JCPD x 2

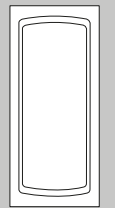

FMU1 x 2

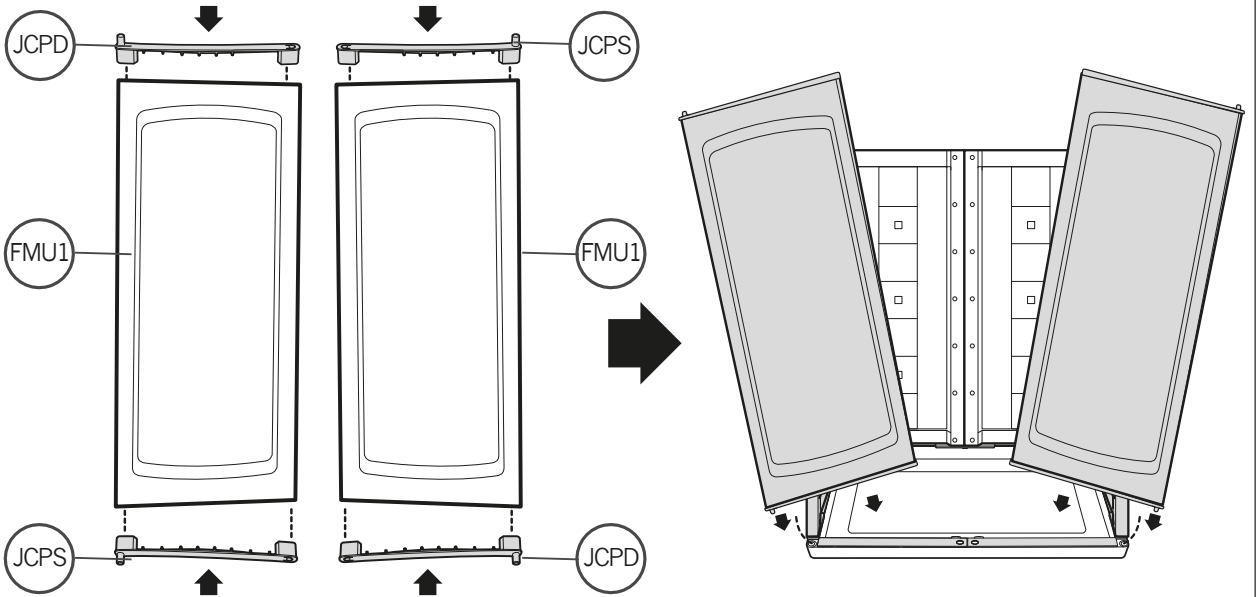

6

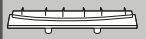

JRBT x 4



JRPS x 1



JRPD x 1



JBT

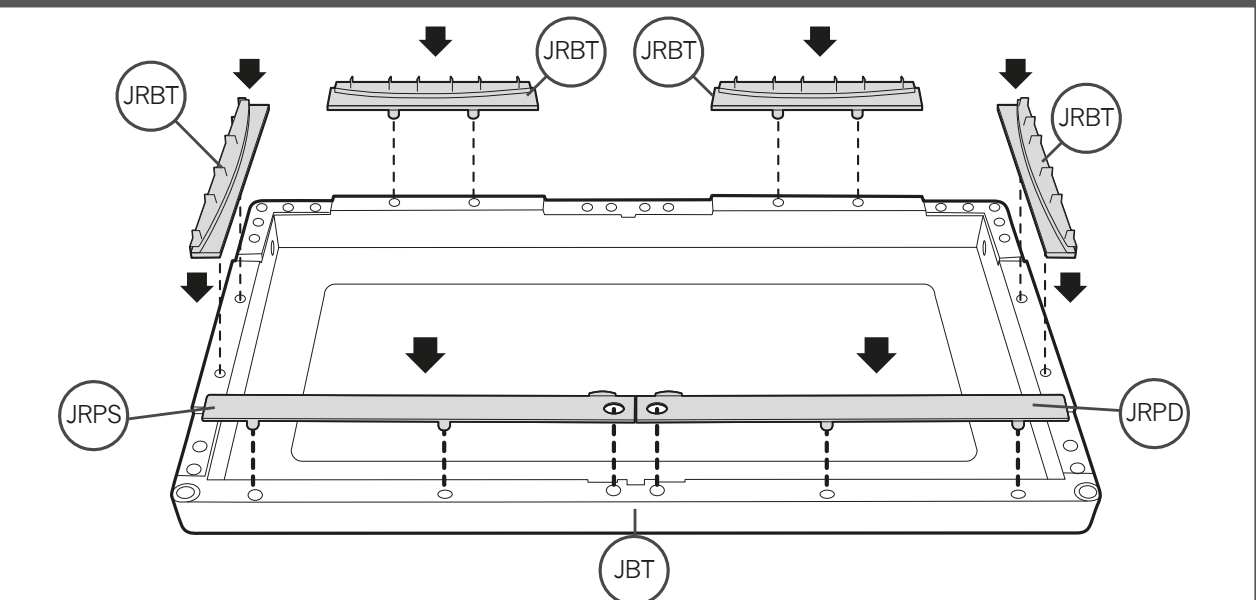

7

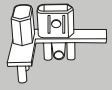

JABD x 1

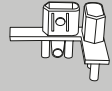

JABS x 1



JCLS x 1



JCLD x 1

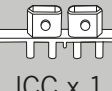

JCC x 1

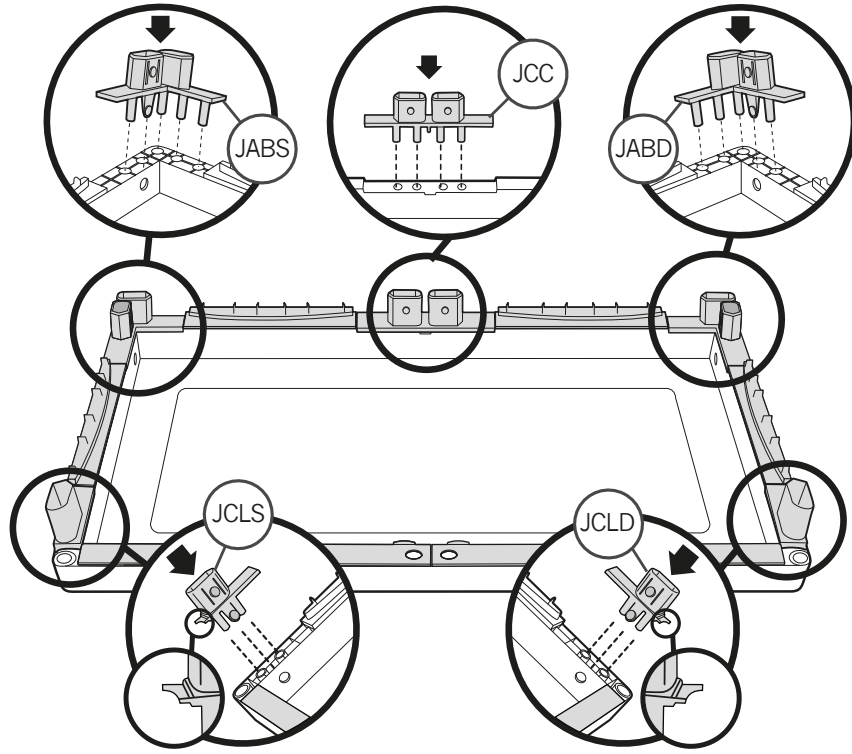

8



UTS x 2



UTD x 2

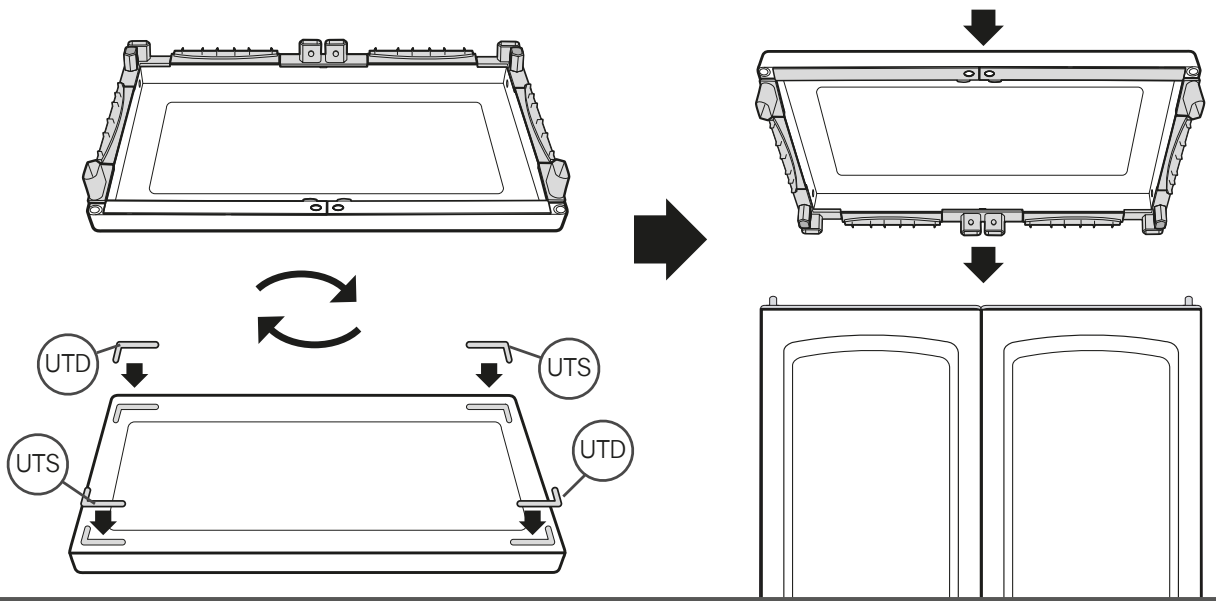

9

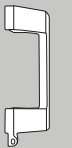

UMD x 1



x 2



x 2

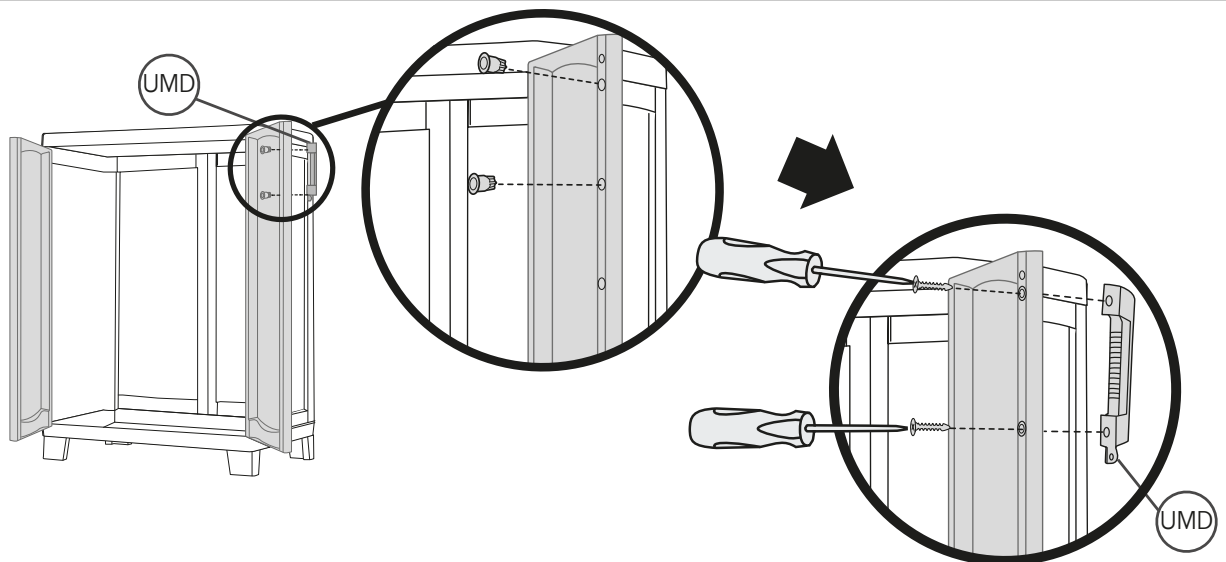

10



UMS x 1



x 2



x 2

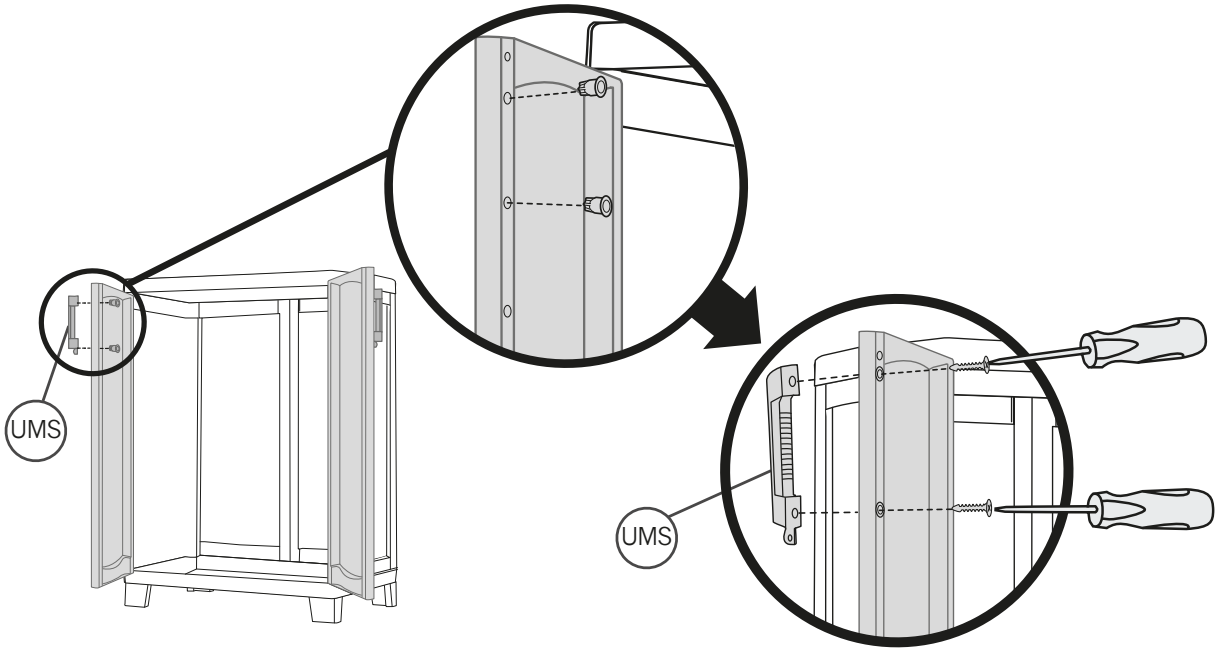

11



JFR x 4



JGR x 4



JRA x 1

